

CENTON

Specialist in Water Heater



SR711
Serene
series Instant Water Heater

An ISO 9001 and ISO 14001 Certified Manufacturer

Singlepoint Series (MY)
Single Heating Element
Left Inlet Plastic Tank

Pages

1. Important Safety Information	2 - 3
2. Heater Contents Checklist	4
3. Part Description	5 - 6
4. Electrical Requirement	7
5. Water Requirement	8
6. Installation Procedures	9 - 10
7. Operating The Shower	11
8. User Maintenance	12
9. Quality Assured	13
10. Temperature Rise Guideline	14
11. Specification	15 - 16

IMPORTANT SAFETY INFORMATION

2

WARNING

- 1) Check the RCD in this heater (refer A) & the RCD at the main switch board (refer B) of the premise at least once a month.

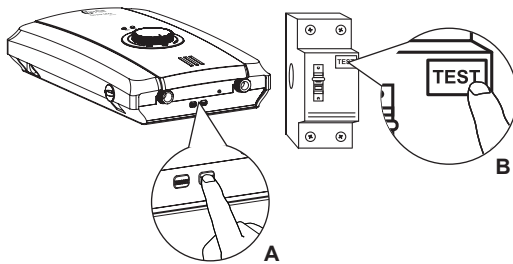

- 2) This product must be earthed.

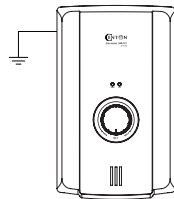

- 3) The shower unit must be installed according to the diagram shown below with inlet / outlet facing downwards & the brand logo facing frontwards (not downwards / upwards). Failure to follow will result in serious damage to the water heater & warranty will be voided.

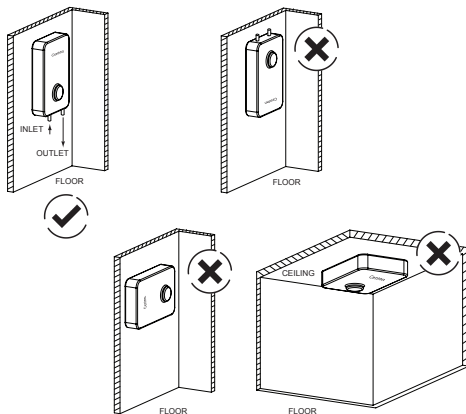

- 4) The outlet point of this heater, hose and handshower act as a vent. They must not be blocked, obstructed or modified in any way. Fittings or any taps not recommended by manufacturer must not be connected. The use of unapproved accessories may not only affect its performance and safety but also invalidate its guarantee.



* Applicable for singlepoint model only

- 5) There are no user serviceable component beneath the cover of this appliance. Only a competent tradesperson should remove the cover.

- 6) Children should be supervised to ensure that they do not play with the appliance.

- 7) Plug, socket, & undersize cable shall not be used.

- 8) Metallic, chrome hose, & conductive control valve shall not be used.

- 9) The water inlet of this appliance shall not be connected to inlet water obtained from any other water heating system.

- 10) This appliance is not intended for use by person (including children) with reduced physical, sensory or mental capabilities, or lack of experience and knowledge, unless they have been given supervision or instruction concerning use of the appliance by a person responsible for their safety.

IMPORTANT SAFETY INFORMATION

3

WARNING

11) To account for future maintenance / servicing, please make sure that this product is installed with:

- a. safe access that is free from obstacles for technicians to reach the location where the product is installed and to do their tasks, and
- b. flexible piping connection (as opposed to fixed / permanent piping connection) so that this product can be detached / removed from its installed location without damaging the piping connection.

Failure to follow may result in additional removal works needed during maintenance / servicing (such as clearance of a pathway to access the location where this product installed, or cutting of fixed piping connection to dismantle this product), hence additional service charges may applied.

CENTON and its technicians will also not be liable to reimburse back any damages or replacement cost for such removal works.

SAFEGUARDING THE ENVIRONMENT



This product may not be treated as household waste. Instead it shall be handed over to the applicable collection point for the recycling of electrical and electronic equipment. Disposal must be carried out in accordance with your local environmental regulations for waste disposal.

Malaysia

Government has launched e-Waste program (commonly known as electrical and electronic waste) to enhance the public awareness towards the responsible e-Waste disposal. Please refer to link below to check compliance collection at your place:

<https://ewaste.doe.gov.my/>

HEATER CONTENTS CHECKLIST

4

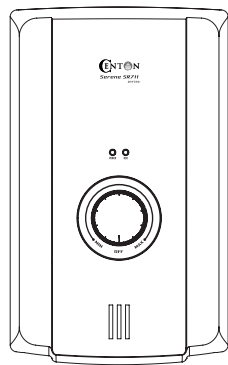

1 x Heater Unit

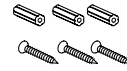

3 x Wall Plugs & Screw Set



1 x Instruction Manual &
Accessory Set Content Checklist

**** Please refer to the Accessory Set Content Checklist (separate printed attachment).***

PART DESCRIPTION

5

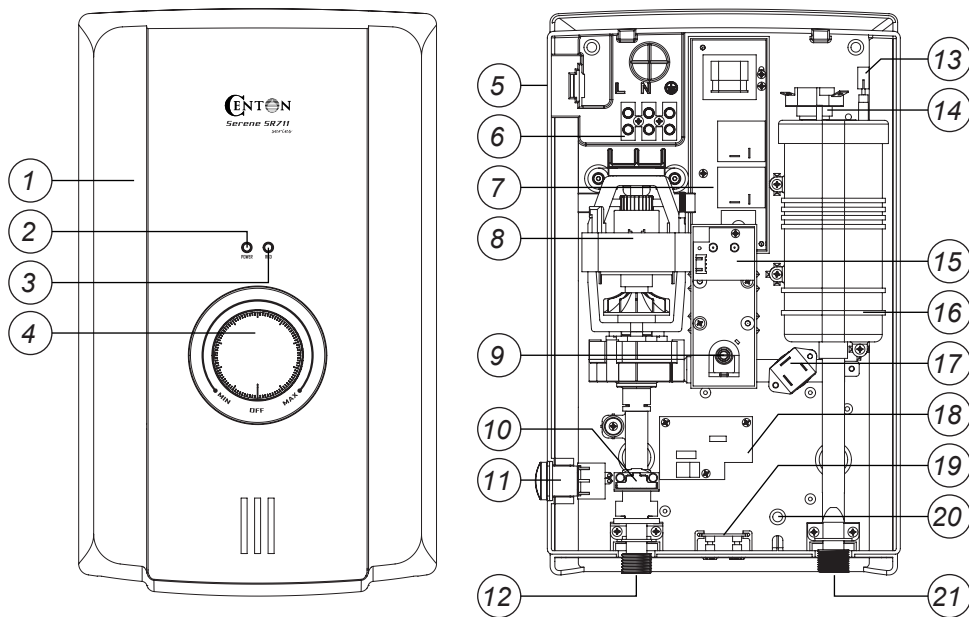

MODEL: SERENE SR711E / SR711EP

- | | |
|-----------------------------|---|
| 1. Heater Cover | 11. Pump Control Unit ** |
| 2. Power Indicator | 12. Heater Inlet |
| 3. RCD Indicator * | 13. Heating Element |
| 4. Temperature Control Knob | 14. Double Function Manual Reset Thermostat |
| 5. Cable Entry | 15. Indicator PCB |
| 6. Terminal Block | 16. Heater Tank Assembly |
| 7. Built-in RCD * | 17. Triac |
| 8. AC Pump Assembly ** | 18. Pump Control Board ** |
| 9. Electronic Control Unit | 19. RCD Test and Reset Board * |
| 10. Flow Switch Assembly | 20. Mounting Holes (3 Nos) |
| | 21. Heater Outlet |

* Model SR711E & SR711EP

** Model SR711EP

PART DESCRIPTION

6

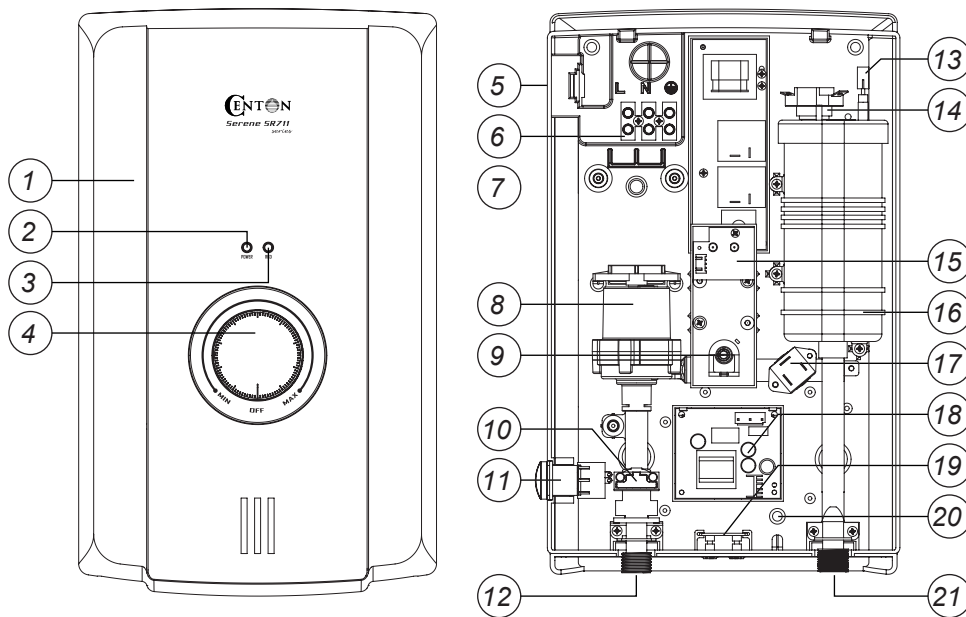

MODEL: SERENE SR711ESP

- | | |
|-----------------------------|---|
| 1. Heater Cover | 11. Pump Control Unit |
| 2. Power Indicator | 12. Heater Inlet |
| 3. RCD Indicator | 13. Heating Element |
| 4. Temperature Control Knob | 14. Double Function Manual Reset Thermostat |
| 5. Cable Entry | 15. Indicator PCB |
| 6. Terminal Block | 16. Heater Tank Assembly |
| 7. Built-in RCD | 17. Triac |
| 8. DC Pump Assembly | 18. Pump Control Board |
| 9. Electronic Control Unit | 19. RCD Test and Reset Board |
| 10. Flow Switch Assembly | 20. Mounting Holes (3 Nos) |
| | 21. Heater Outlet |

*** Optional Item**



WARNING THIS APPLIANCE MUST BE EARTHED

Note: An approved type of Residual Current Device (RCD) of 10mA sensitivity should be installed in conjunction with the heater.

- 1) Installation must be carried out by a qualified electrician.
- 2) The shower heater unit must be connected to its own independent electrical circuit.
- 3) Lead the power cable from the indoor fuse distributor board or Miniature Circuit Breaker (MCB) to an 'ON/OFF' Double-Pole switch outside the bathroom.
- 4) The water heater must be permanently connected to the electricity supply through a double-pole linked switch having a contact of separation of at least 3mm in all poles incorporated in fixed wiring.
- 5) This switch must be out of reach of a person using a shower.
- 6) Correct size of wire conductor corresponding to different electrical loading should be used. Minimum cable size must not be less than specified in Table A with accordance to the rated power.
- 7) For connection within the shower cubicle & below the ceiling, the connection box shall be IPX5 rated.
- 8) Only fixed & permanent connection is allowed, plug & socket shall not be used. In the case where a direct connection cannot be made to the water heater, only correctly sized approved connector & connection box shall be used.
- 9) An approved, correctly sized copper PVC insulated flexible cables with maximum 1.5m lengths shall be used to connect water heater to the connection box by referring cable size in the Table A as below.
- 10) The installation shall comply with GP/ST/No.6/2016, Guideline for the Design, Installation, Inspection, Testing, Operation & Maintenance of Water Heater Systems by Energy Commission. Refer to Figure A.

Cable Sizes Table

Voltage (V~)	Power (kW)	Amperes (A)	Recommended Conductor Size			Fuse / MCB (A)	ON/OFF Switch (A)
			mm ²	Cable for Fixed Wiring	PVC Flexible Cables		
220~ 50/60Hz	3.5	16.0	4.0	7/0.85mm	56/0.30	20	20
	4.4	20.0	4.0	7/0.85mm	56/0.30	25	25
	4.5	20.5	4.0	7/0.85mm	56/0.30	25	25
	5.5	25.0	4.0	7/0.85mm	56/0.30	32	32
	6.0	27.3	4.0	7/0.85mm	56/0.30	32	32
	7.0	31.8	6.0	7/1.04mm	84/0.30	40	40
230~ 50/60Hz	3.3	14.3	4.0	7/0.85mm	56/0.30	20	20
	3.5	15.2	4.0	7/0.85mm	56/0.30	20	20
	4.5	19.6	4.0	7/0.85mm	56/0.30	25	25
	6.0	26.1	4.0	7/0.85mm	56/0.30	32	32
240~ 50/60Hz	3.6	15.0	4.0	7/0.85mm	56/0.30	20	20
	3.72	15.5	4.0	7/0.85mm	56/0.30	20	20
	3.8	15.9	4.0	7/0.85mm	56/0.30	20	20
	4.2	17.5	4.0	7/0.85mm	56/0.30	20	20
	4.8	20.0	4.0	7/0.85mm	56/0.30	25	25
	5.4	22.5	4.0	7/0.85mm	56/0.30	32	32

Table A

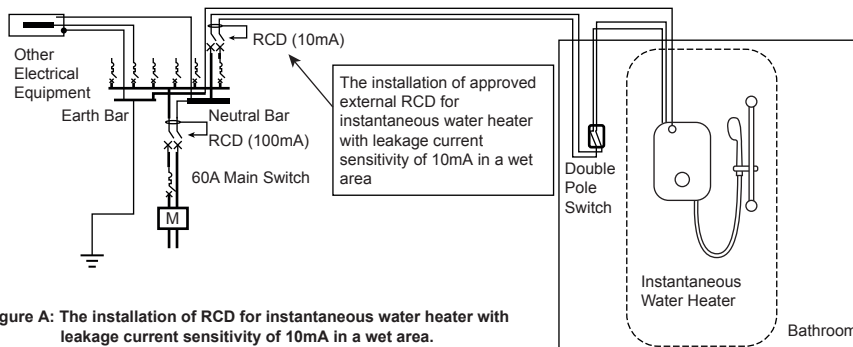

Figure A: The installation of RCD for instantaneous water heater with leakage current sensitivity of 10mA in a wet area.

PLUMBING SCHEMATIC DIAGRAM

1. Diagram on right shows a typical system layout.
2. Do not use joining compounds on any pipe fittings for the installation.
3. The unit works at minimum water flow rate of 2 litre/min. An incoming water flow rate of 5 litre/min and above would excel its performance.
4. The water inlet of this product shall not be connected to inlet water obtained from any other water heating system.
5. This product must be permanently connected to the water mains & not connected by a hose set.

WARNING

THIS PRODUCT IS NOT TO BE USED FOR A POTABLE WATER SUPPLY

SITTING OF THE SHOWER

FOR EASE OF SERVICING, THE UNIT MUST ALWAYS BE MOUNTED ON THE SURFACE OF TILED WALL. NEVER TILE UP TO THE UNIT.

1. This product is splash-proof rated and is approved for use in shower cubicles & over baths.
2. Do not install the unit in a position where the sprayhead will consistently direct water over it.
3. The shower unit **MUST** be positioned vertically.

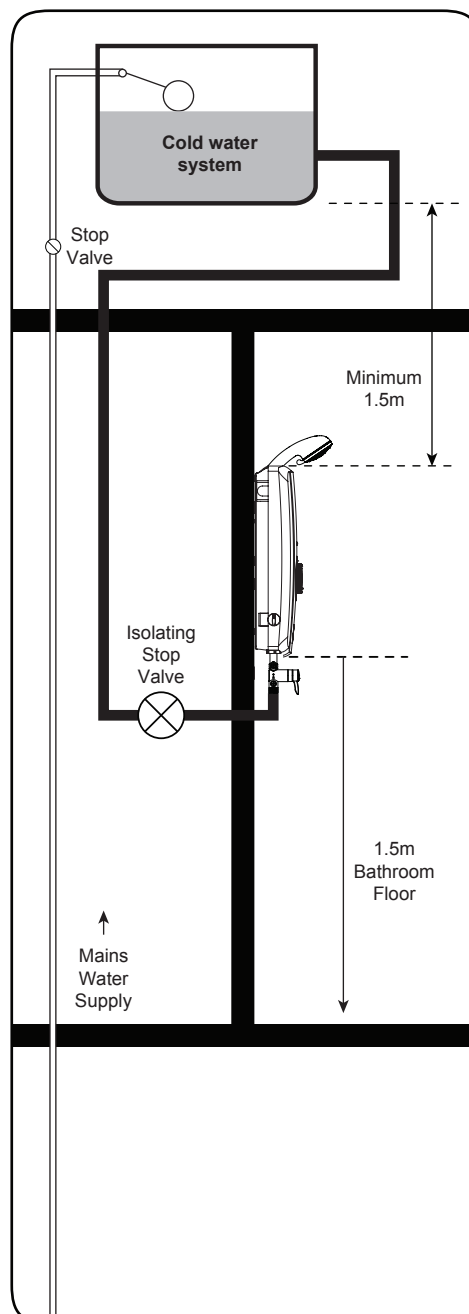

FIXING THE SHOWER TO THE WALL

CAUTION:

It is important to mount the shower unit to a flat surface otherwise difficulty may be encountered when fitting the cover and subsequent.

1. Unscrew the screw at bottom of heater and remove the cover by lifting the bottom of cover upward.

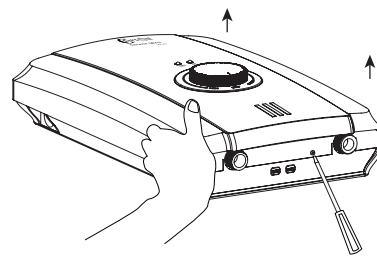

Remove the cover

2. Determine the suitable position where electrical cable & inlet water supply is reachable.

Mark the position of the mounting holes on wall.

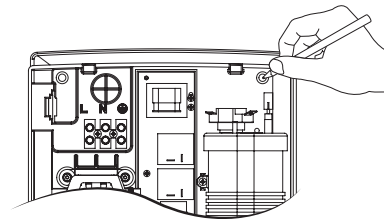

Mark the mounting holes

3. Drill the holes with 5.0mm diameter drill bit and insert the wall plugs provided.

Secure heater unit onto wall with screws provided.

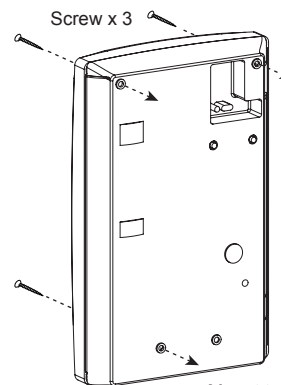

Mount to wall

PLUMBING CONNECTIONS

CAUTION:
Complete the process before wiring connection

1. Connect the water supply to the inlet of stop valve via 15mm plastic pipe using a 15mm x 15mm elbow compression fitting.

Note:

- i) **DO NOT** apply excessive force when making these connections.
- ii) If PVC glue is used during the installation, please ensure the glue is dried 30 mins after applying, to prevent interfering of flow switch operation & possibly blockage on the shower head

2. Feed the stop valve by securing it to the unit's inlet.

Note: Ensure the supplied rubber washer is in place before connecting stop valve to inlet.

3. Feed the other point of stop valve to incoming water supply.
4. Turn ON water supply and check for leaks in the pipework connection to the shower.

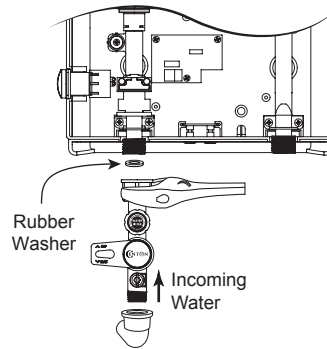

ELECTRICAL CONNECTIONS

WARNING
THIS APPLIANCE MUST BE EARTHED

1. Switch OFF electrical mains before carrying on the electrical work.
2. Insert electrical cable through the rubber grommet for side entry or wall embedded entry.
3. Connect cable to the Terminal Block and fully tighten them as follows:

- Red or Brown Live
- Black or Blue Neutral
- Green/Yellow or Yellow/Green Earth (≡)

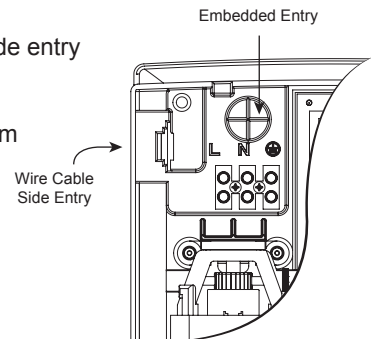



Warning

Improper earthing may result in malfunctioning to the RCD & harmful to user.
Never use the heater if there is doubt on the Earthing installation.

1. RCD

Switch ON the heater switch at outside the bathroom. The RCD indicator will light up.
Note: There will be no light on RCD display if RCD is tripped.

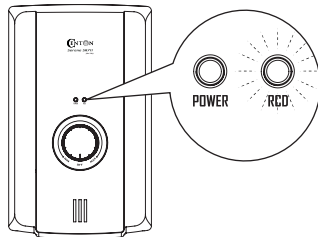

2. Press once on the stopvalve round button to allow water flow through the unit. (You may stop the shower by pressing stop valve round button again)

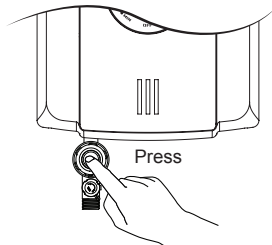

3. The speed of shower pump can be controlled by turning Pump Speed Control Knob located on left of shower unit (for Pump model only).

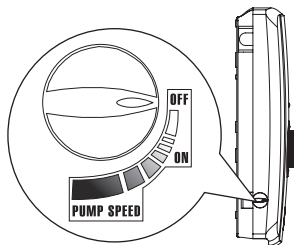

4. Turn on Temperature Control Knob by turning it clockwise. Power light will turn ON.

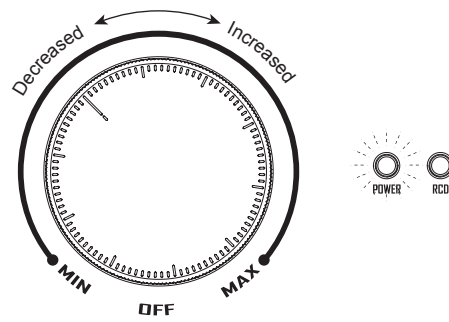

5. The built-in RCD can be tested by pressing 'TEST' button on bottom of shower unit. The POWER & light should turn OFF when 'TEST' button is pressed and restored when 'RESET' button is pressed. Note: Do not use the heater. Contact service agent immediately if nothing happen when these buttons are pressed (for RCD model only).

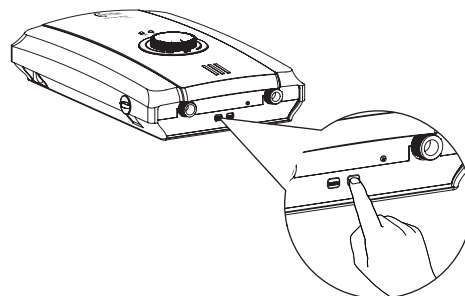

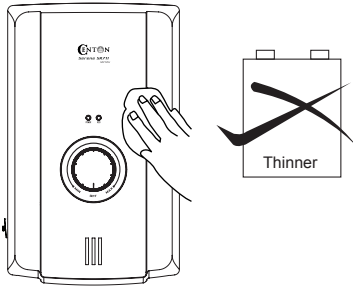

DO NOT USE THINNER, ALCOHOL OR PETROL

You may clean the heater with a damp cloth and mild detergent but do not use thinner, alcohol, petrol or any other corrosive solutions.

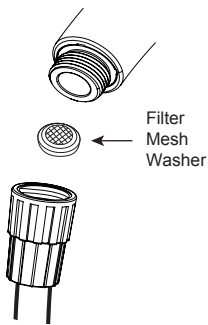

CLEAN FILTER REGULARLY

The spray head & filter must be descaled regularly in order to maintain the performance of the shower.

- a) - Disconnect the sprayhead from the hose.
- Remove filter and clean it using a soft brush.
- Wash it under running water.

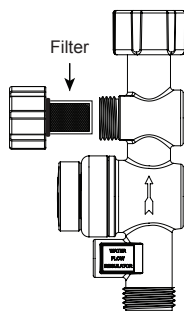

b) **RIGHT ANGLE STOP VALVE (OPTIONAL)**

- Disconnect the water filter from the stop valve.
- Flush the filter with water.
- Reassemble water filter to its position.

All Centon heaters are tested before leaving the factory. With proper care and usage, the heaters are durable, safe and reliable. Use only accessories recommended by the manufacturer.

WARNING

1. The appliance must be earthed.
2. Do not use plumbing cement on connection. If necessary, use only thread or sealant tape.
3. If the RCD does not trip to 'OFF' position each time the 'TEST' button is pressed, contact your sales agent for repair immediately (for RCD model only).
4. If your water heater malfunctions, immediately switch off the mains. Then contact the sales agent for repair. Never attempt to repair the unit yourself.

TROUBLE SHOOTING

MALFUNCTIONING PROBLEMS	CAUSE OF PROBLEMS	SOLUTION
1) No shower coming out from heater.	a) Dirt particles blocking inlet hole or incoming valve.	a) Remove and clean incoming valve.
2) No hot water.	a) Electrical malfunctioning. b) Thermal Cut-out has operated. c) Malfunctioning on Flow Switch Assembly.	(a.b.c) Turn off the main switch and have the unit checked by qualified electrician/agent.
	d) Reduce in ambient water temperature.	d) Reduce the water flow rate.
3) Water too hot even at low temperature.	a) Not enough water flowing through the unit.	a) Refer to (1)
	b) Increase in ambient water temperature.	b) Increase the water flow rate.
4) Water suddenly goes cold.	a) Interrupted of power supply.	a) Check supply or other appliances. Consult qualified electrician/agent if necessary.
	b) Thermostat (Auto) Cut-off	b) Turn off the Temperature Control Knob from 'ON' to 'OFF', to have a warm or cold water to reset back the thermostat.
5) Water turn off, indicator light still on (power still on).	a) Flow switch malfunction.	a) Turn off the main switch immediately, and replace Flow Switch by qualified electrician.

TEMPERATURE RISE GUIDELINE

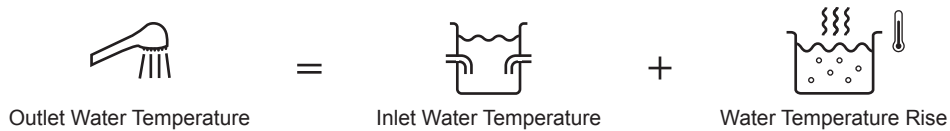

Water temperature rise depends on 3 factors:

Inlet Water Temperature	Heating Element Power	Water Flow Rate
<p style="font-size: small; text-align: center;">Inlet Water Temperature Low Water Temperature Rise Low</p>	<p style="font-size: small; text-align: center;">kW ↑ Heating Element Power High Water Temperature Rise High</p>	<p style="font-size: small; text-align: center;">Water Flow Rate High Water Temperature Rise Low</p>
<p>If the same heaters are used in KL City Centre and in Genting Highlands, the one used in KL City Centre will have hotter output temperature as compared to the heater that is being used in Genting Highlands.</p>	<p>A water heater with 4.2kW heating element will generate more heat as compared to a 3.6kW heating element. (refer to the first row in the table below)</p>	<p>A condominium with higher water pressure / high water flow rate will have colder output temperature as compared to a landed property with lower water pressure. (refer to the first column in the table below)</p>

Average Instant Water Heater's heating element used for:

- Malaysian Market - 3.6kW to 4.2kW
- Highlands (Genting, Cameron, Fraser Hills, etc.) - 4.8kW to 5.4kW

Flow Rate (LPM)		Heating Element			
		3.6kW	4.2kW	4.8kW	5.4kW
Low Flow Rate	1	45.9	53.5	61.2	68.8
	2	22.9	26.8	30.6	34.4
	3	15.3	17.8	20.4	22.9
	4	11.5	13.4	15.3	17.2
Recommended Flow Rate	5	9.2	10.7	12.2	13.8
	6	7.6	8.9	10.2	11.5
	7	6.6	7.6	8.7	9.8
High Flow Rate	8	5.7	6.7	7.6	8.6
	9	5.1	5.9	6.8	7.6
	10	4.6	5.4	6.1	6.9
	11	4.2	4.9	5.6	6.3
	12	3.8	4.5	5.1	5.7
	13	3.5	4.1	4.7	5.3
	14	3.3	3.8	4.4	4.9
	15	3.1	3.6	4.1	4.6
	16	2.9	3.3	3.8	4.3
	17	2.7	3.1	3.6	4.0
	18	2.5	3.0	3.4	3.8
	19	2.4	2.8	3.2	3.6
	20	2.3	2.7	3.1	3.4

Table: Temperature Rise (°C) Based on Heater Element (kW) & Flow Rate (LPM)

*The temperature rise table above is solely for reference purposes only. Actual results may vary due to other factors such as heat loss.

Model Electrical Rating	- Available from 3kW - 6.0kW, 220-240Vac, 50/60Hz
Minimum Water Flow Rate	- 2 liters/ min
Minimum Water Inlet Pressure (Open Outlet)	- 20kPa (0.2bar / 2.9psi)
Maximum Water Inlet Pressure (Open Outlet)	- 0.38MPa (3.8bar / 55psi)
Shower Temperature Control	- Electronic Control
Water Connection	- 15mm dia. (1/2" BSP)
Heater Dimension	- 239mm x 392mm x 99mm (H)
Heater Weight (without Pump)	- 1.75kgs
Heater Weight (AC Pump)	- 2.68kgs

Schematic Wiring Diagram

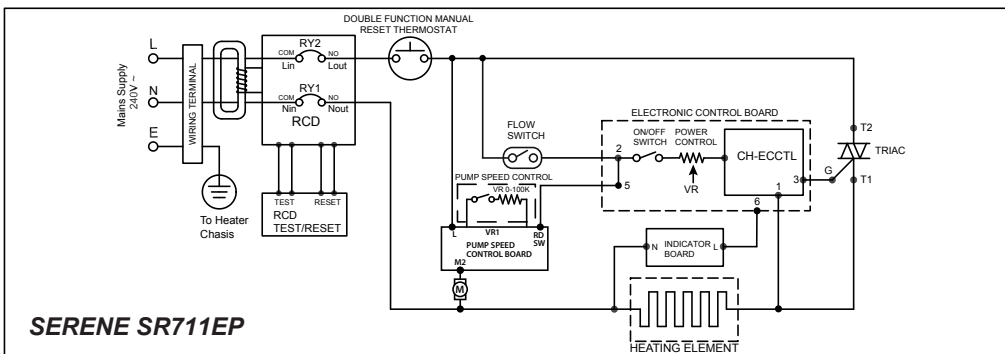
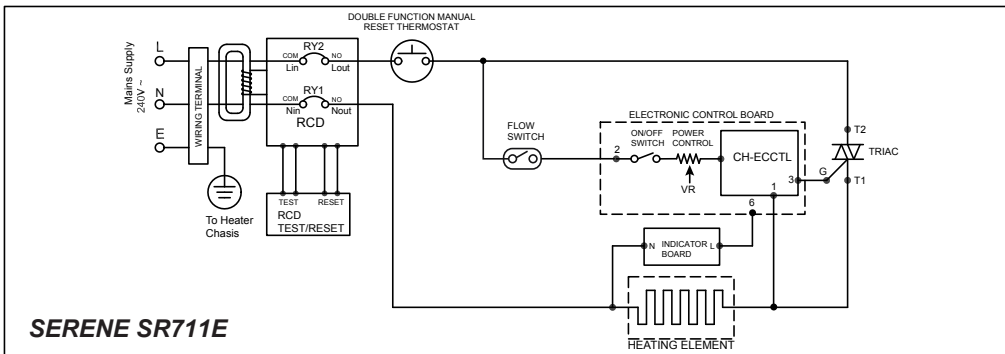

Model Electrical Rating	- Available from 3kW - 6.0kW, 220-240Vac, 50/60Hz
Minimum Water Flow Rate	- 2 liters/ min
Minimum Water Inlet Pressure (Open Outlet)	- 20kPa (0.2bar / 2.9psi)
Maximum Water Inlet Pressure (Open Outlet)	- 0.38MPa (3.8bar / 55psi)
Shower Temperature Control	- Electronic Control
Water Connection	- 15mm dia. (1/2" BSP)
Heater Dimension	- 239mm x 392mm x 99mm (H)
Heater Weight (DC Pump)	- 2.06kgs

Schematic Wiring Diagram

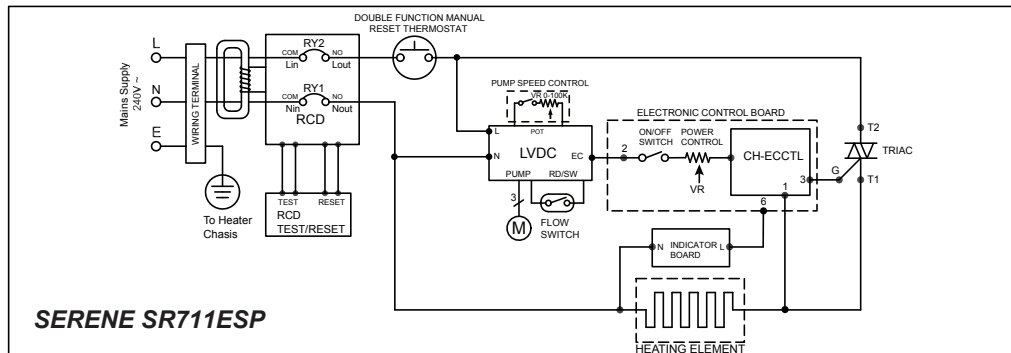

ref. number: 4.676K-4_Rev4_05072024

* In addition, this instruction manual shall also be available upon requested by email to support@centonia.my
 * The product's specification & shower accessories shown in this instruction manual are correct at the time of printing & subject to change without prior notice

ACCESSORY SET CONTENT CHECKLIST

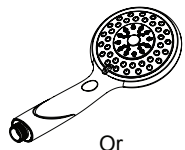

Or

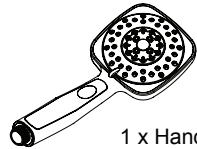

1 x Handshower



1 x Filter Mesh Washer

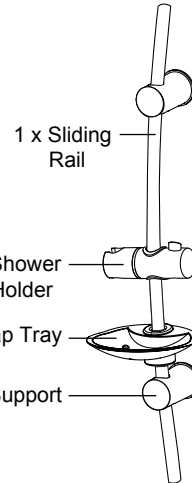

2 x Screw & Wall Plug Set 

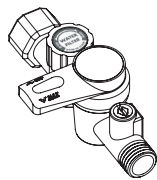

1 x Right Angle Stop Valve

Or

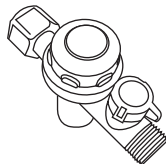

1 x Pop Start Stop Valve

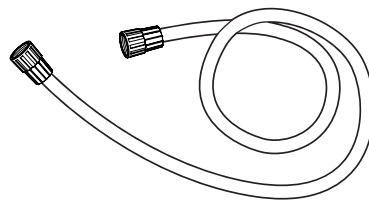

1 x Flexible Hose

ACCESSORY INSTALLATION

Full Shower Accessory

1. Fix the rotatable Soap Dish and Shower Holder onto the Sliding rail as illustrated.
2. Determine the suitable height for shower accessories and mark for the mounting holes.
3. Mounting holes are available after Rail Support Caps are removed.
4. Drill the mounting holes and insert Wall Plugs provided.
5. Secure the accessories set with Screws provided & cover the Rail Support Caps.
6. Feed the Flexible Hose by securing to the unit outlet & Handshower.
7. Ensure the supplied Rubber Washer is in place at the outlet & the Filter Mesh Washer at the Handshower.

